

0 603 261 803

Stand } ~~10-08~~
Issue } 03-04-07

Fig./Abb. 1

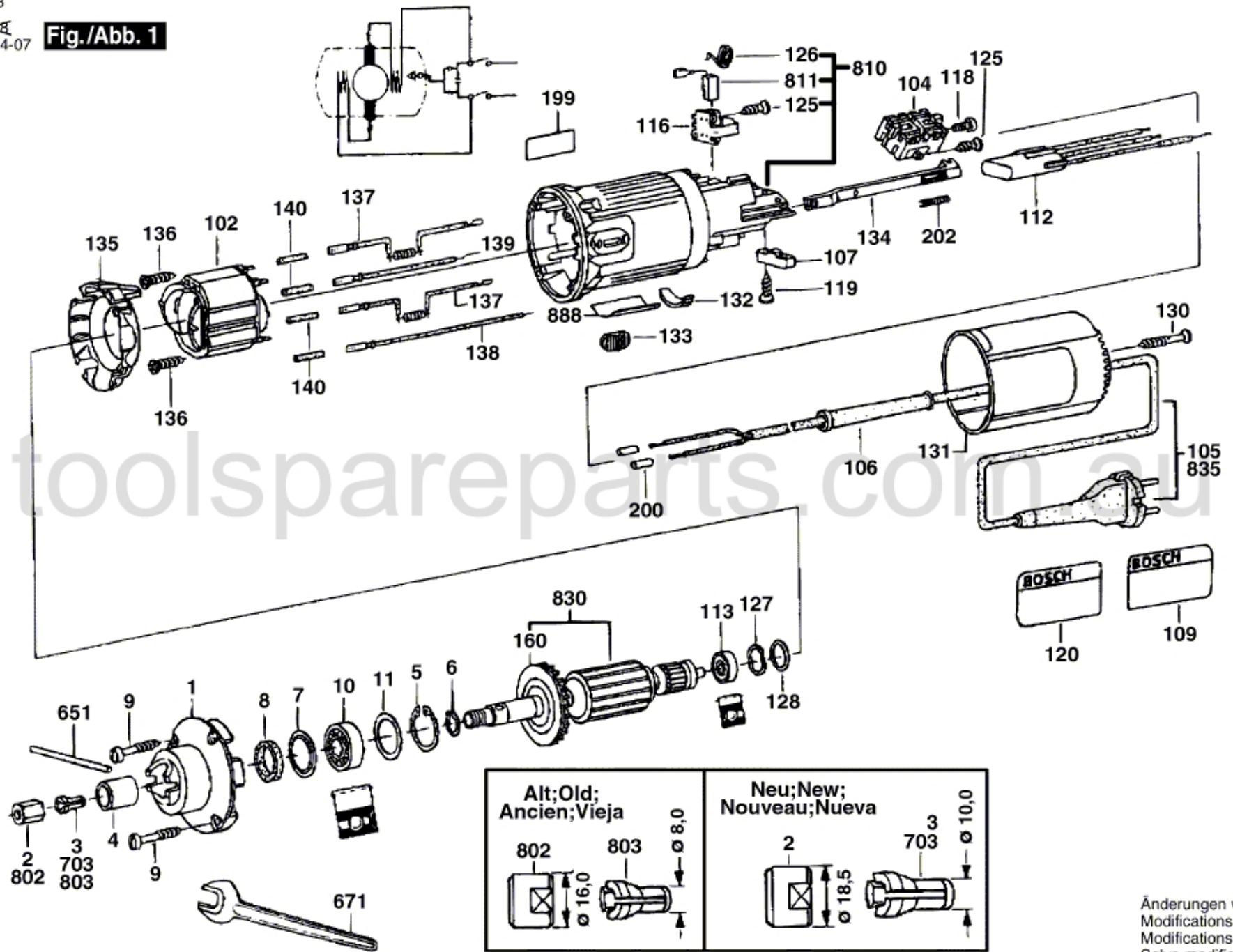

Änderungen vorbehalten
Modifications reserved
Modificaciones reservadas
Salvo modificaciones